



KERN & Sohn GmbH

Ziegelei 1
D-72336 Balingen
E-Mail: info@kern-sohn.com

Tel: +49-[0]7433- 9933-0
Fax: +49-[0]7433-9933-149
Internet: www.kern-sohn.com

Operating instruction Price computing scale

KERN RPB-N

Version 1.4
06/2009
GB



RPB-N-BA-e-0914



KERN RPB-N

Version 1.4 06/2009

Operating instruction Price computing scale

Contents

1	Technical data	4
2	Declaration of conformity	7
3	Appliance overview	8
3.1	Overview of display	10
3.1.1	Display weight	11
3.1.2	Display basic price	11
3.1.3	Display sales price	11
3.2	Keyboard overview	12
4	Basic Information (General)	13
4.1	Proper use	13
4.2	Improper Use	13
4.3	Warranty	13
4.4	Monitoring of Test Resources	14
5	Basic Safety Precautions	14
5.1	Pay attention to the instructions in the Operation Manual	14
5.2	Personnel training	14
6	Transport and storage	14
6.1	Testing upon acceptance	14
6.2	Packaging	14
7	Unpacking, Setup and Commissioning	15
7.1	Installation Site, Location of Use	15
7.2	Unpacking	15
7.2.1	Setup	15
7.2.2	Scope of delivery	16
7.3	Mains connection	16
7.4	Battery power supply	16
7.5	Initial Commissioning	16
7.6	Adjustment	17
7.7	Verification	19
7.7.1	Jumper and seals	20
8	Operation	21
8.1	Switch on/off and set zero	21

8.2	Simple weighing	21
8.3	Weighing with taring	22
8.4	Weighing with price determination	23
8.4.1	Manual input of a basic price	23
8.4.2	Saving and calling up a basic price	23
8.5	AUTO CLEAR	25
9	Display background illumination	26
10	AUTO OFF function	27
11	Data Interface RS 232C	28
11.1	Technical data	28
11.2	Pin allocation for the balance output socket (front view)	28
11.3	Parameter selection	28
11.4	Setting the date/time	29
11.5	Remote control instructions	29
12	Service, maintenance, disposal	30
12.1	Cleaning	30
12.2	Service, maintenance	30
12.3	Disposal	30
13	Instant help	31

1 Technical data

KERN	RPB 3K1NM	RPB 6K2NM
<i>Readability (d)</i>	1 g	2 g
<i>Weighing range (max)</i>	3 kg	6 kg
<i>Minimum load</i>	20 g	40 g
<i>Verification value</i>	1 g	2 g
<i>Verification class</i>	III	III
<i>Reproducibility</i>	1 g	2 g
<i>Linearity</i>	± 2 g	± 4 g
<i>Stabilization time</i>	2 sec.	2 sec.
<i>Recommended adjusting weight (not supplied)</i>	3 kg (M2)	6 kg (M2)
<i>Warm up time (operating temperature)</i>	10 min	
<i>Net weight (kg)</i>	4,3	
<i>Dimensions of the housing (B x D x H)</i>	315 x 355 x 110	
<i>Weighing plate, stainless steel</i>	225 x 275 mm	
<i>Weighing unit</i>	€/kg; €/g	
<i>Permissible ambient condition</i>	-10° C to 40° C	
<i>Humidity of air</i>	15% - 85% (not condensing)	
<i>Voltage</i>	230 V (AC)	
<i>Battery</i>	Operating time ca. 70 hrs. / loading time ca. 12 hrs.	
<i>Data interface</i>	RS 232C	

KERN	RPB 15K5NM	RPB 30K10NM	RPB 3K1HNM
<i>Readability (d)</i>	5 g	10 g	1g
<i>Weighing range (max)</i>	15 kg	30 kg	3 kg
<i>Minimum load</i>	100 g	200 g	20 g
<i>Verification value</i>	5 g	10 g	1 g
<i>Verification class</i>	III	III	III
<i>Reproducibility</i>	5 g	10 g	1 g
<i>Linearity</i>	± 10 g	± 20 g	± 2 g
<i>Stabilization time</i>	2 sec.	2 sec.	2 sec.
<i>Recommended adjusting weight (not supplied)</i>	15 kg (M2)	30 kg (M2)	3 kg (M2)
<i>Net weight (kg)</i>	4,3	4,3	4,7
<i>Dimensions of the housing (B x D x H)</i>	315 x 355 x 110	315 x 355 x 110	315 x 355 x 110 without tripod 315 x 355 x 540 with tripod
<i>Weighing plate, stainless steel</i>	225 x 275 mm		
<i>Warm up time (operating temperature)</i>	10 min		
<i>Weighing unit</i>	€/kg; €/g		
<i>Permissible ambient condition</i>	-10° C to 40° C		
<i>Humidity of air</i>	15% - 85% (not condensing)		
<i>Voltage</i>	230 V		
<i>Battery</i>	Operating time ca. 70 hrs. / loading time ca. 12 hrs.		
<i>Data interface</i>	RS 232C		

KERN	RPB 6K2HNM	RPB 15K5HNM	RPB 30K10HM
<i>Readability (d)</i>	2 g	5 g	10 g
<i>Weighing range (max)</i>	6 kg	15 kg	30 kg
<i>Minimum load</i>	40 g	100 g	200 g
<i>Verification value</i>	2 g	5 g	10 g
<i>Verification class</i>	III	III	III
<i>Reproducibility</i>	2 g	5 g	10 g
<i>Linearity</i>	± 4 g	± 10 g	± 20 g
<i>Stabilization time</i>	2 sec.	2 sec.	2 sec.
<i>Recommended adjusting weight (not supplied)</i>	6 kg (M2)	15 kg (M2)	30 kg (M2)
<i>Warm up time (operating temperature)</i>	10 min		
<i>Net weight (kg)</i>	4,7		
<i>Dimensions of the housing (B x D x H)</i>	315 x 355 x 110 without tripod 315 x 355 x 540 with tripod		
<i>Weighing plate, stainless steel</i>	225 x 275 mm		
<i>Weighing unit</i>	€/kg; €/g		
<i>Permissible ambient condition</i>	-10° C to 40° C		
<i>Humidity of air</i>	15% - 85% (not condensing)		
<i>Voltage</i>	230 V		
<i>Battery</i>	Operating time ca. 70 hrs. / loading time ca. 12 hrs.		
<i>Data interface</i>	RS 232C		

2 Declaration of conformity



KERN & Sohn GmbH

D-72322 Balingen-Frommern

Postfach 4052

E-Mail: info@kern-sohn.de

Tel: 0049-[0]7433- 9933-0

Fax: 0049-[0]7433-9933-149

Internet: www.kern-sohn.de

Konformitätserklärung

Declaration of conformity for apparatus with CE mark

Konformitätserklärung für Geräte mit CE-Zeichen

Déclaration de conformité pour appareils portant la marque CE

Declaración de conformidad para aparatos con marca CE

Dichiarazione di conformità per apparecchi contrassegnati con la marcatura CE

- English** We hereby declare that the product to which this declaration refers conforms with the following standards.
- Deutsch** Wir erklären hiermit, daß das Produkt, auf das sich diese Erklärung bezieht, mit den nachstehenden Normen übereinstimmt.
- Français** Nous déclarons avec cela responsabilité que le produit, auquel se rapporte la présente déclaration, est conforme aux normes citées ci-après.
- Español** Manifestamos en la presente que el producto al que se refiere esta declaración está de acuerdo con las normas siguientes
- Italiano** Dichiariamo con ciò che il prodotto al quale la presente dichiarazione si riferisce è conforme alle norme di seguito citate.

Electronic Scale: KERN RPB..NM

Mark applied	EU Directive	Standards
	89/336/EEC EMC	EN 61326
	73/23/EEC Low Voltage	EN 60950 EN 61010

Date: 10.01.2007

Signature: 

Gottl. KERN & Sohn GmbH
Management

Gottl. KERN & Sohn GmbH, Ziegelei 1, D-72336 Balingen, Tel. +49-[0]7433/9933-0, Fax +49-[0]7433/9933-149

3 Appliance overview

Models without vertical display:

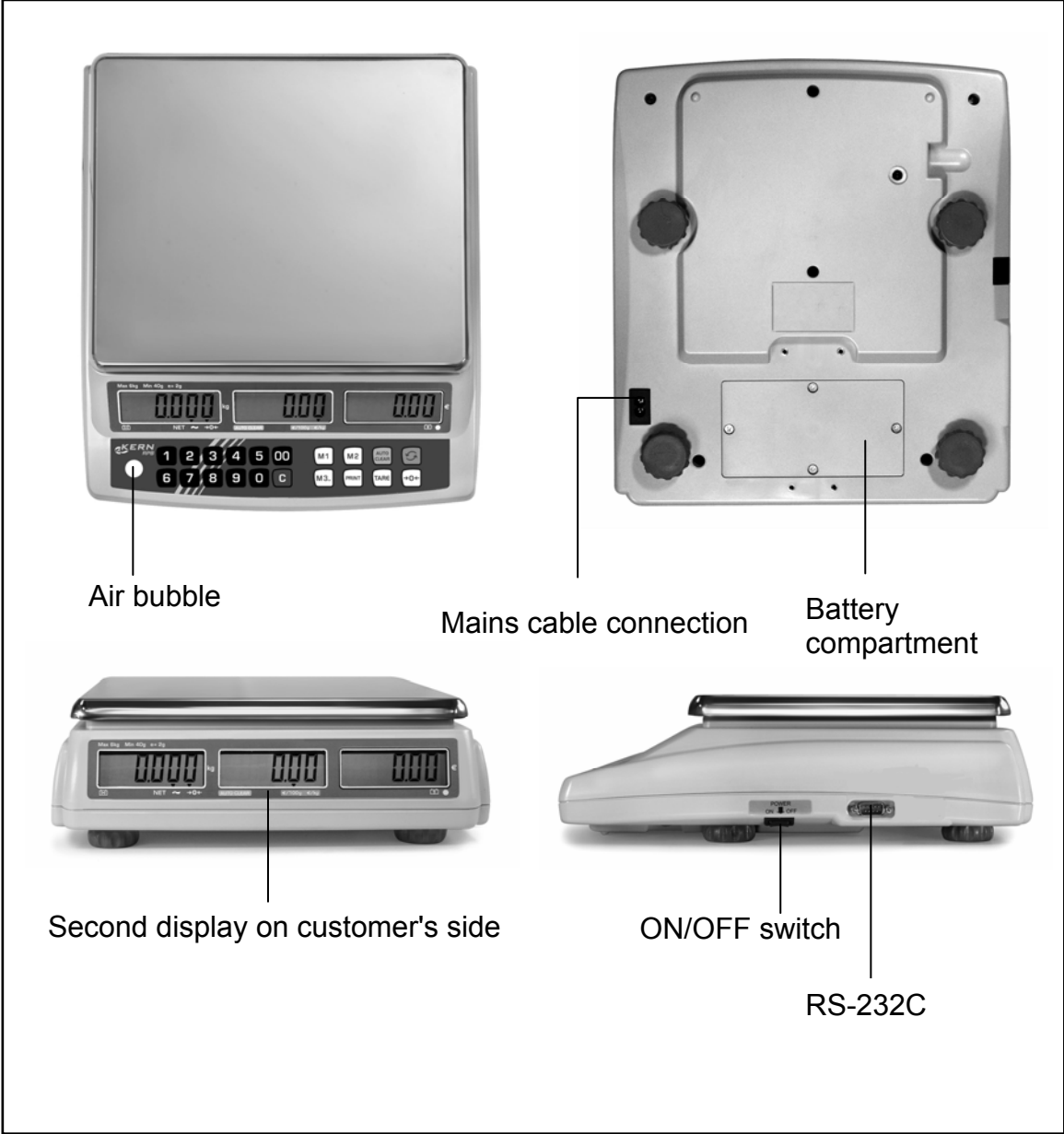

Models with vertical display:

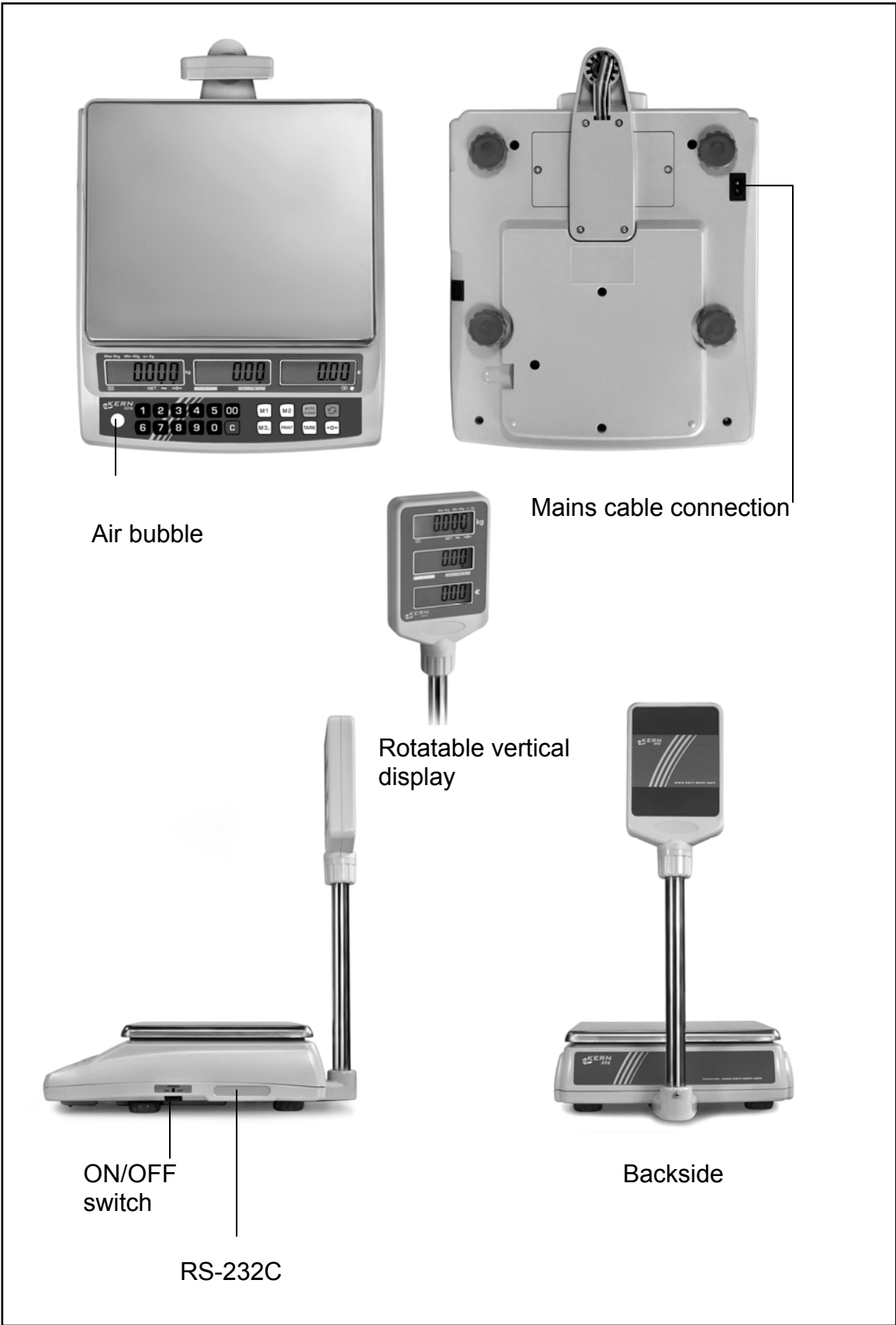

3.1 Overview of display

Operator display balance:





Vertical display for models with tripod:



3.1.1 Display weight

Here, the weight of your goods is displayed.

The arrows above the symbols show:

	Battery very low
NET	Net weight
	Stability display
→0←	Zeroing display

3.1.2 Display basic price

Here, enter your basic price in €/kg or €/100 g via keyboard. The basic price can be switched to €/kg or €/100 g.

The arrows above the symbols show:









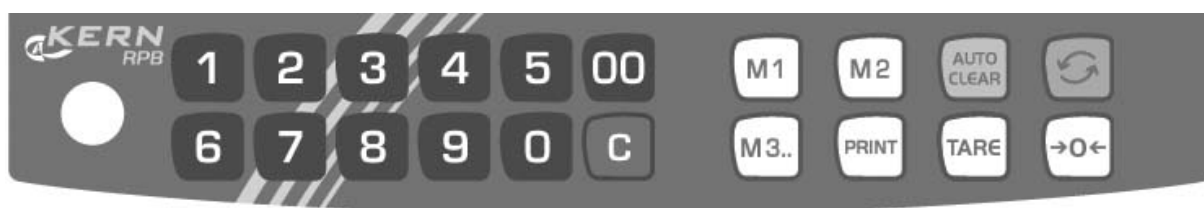

AUTO CLEAR	Set basic price is deleted automatically when balance is unloaded
€/100 g	Saved basic price in €/100 g
€/kg	Saved basic price in €/kg

3.1.3 Display sales price

Here the sales price is displayed in Euro [€].

3.2 Keyboard overview



Choice	Function
	<ul style="list-style-type: none"> Number keys, enter basic price /PLU
	<ul style="list-style-type: none"> Delete key
 	<ul style="list-style-type: none"> Saving and calling up the two most frequently used PLU values
	<ul style="list-style-type: none"> Saving and calling up the other PLU values
	<ul style="list-style-type: none"> Taring key Save
	<ul style="list-style-type: none"> Zeroing key Back to weighing mode
	<ul style="list-style-type: none"> Set basic price is deleted automatically when balance is unloaded
	<ul style="list-style-type: none"> Switch-over key €/kg or €/100 g
	<ul style="list-style-type: none"> Output of the weight to an external appliance Parameter selection

4 Basic Information (General)

4.1 Proper use

The balance you purchased is intended to determine the weighing value of material to be weighed. It is intended to be used as a “non-automatic“ balance, i.e. the material to be weighed is manually and carefully placed in the centre of the weighing plate. As soon as a stable weighing value is reached the weighing value can be read.

4.2 Improper Use

Do not use balance for dynamic weighings. In the event that small quantities are removed or added to the material to be weighed, incorrect weighing results can be displayed due to the “stability compensation“ in the balance. (Example: Slowly draining fluids from a container on the balance.)

Do not leave permanent load on the weighing plate. This may damage the measuring system.

Impacts and overloading exceeding the stated maximum load (max) of the balance, minus a possibly existing tare load, must be strictly avoided. Balance may be damaged by this.

Never operate balance in explosive environment. The serial version is not explosion protected.

The structure of the balance may not be modified. This may lead to incorrect weighing results, safety-related faults and destruction of the balance.

The balance may only be used according to the described conditions. Other areas of use must be released by KERN in writing.

4.3 Warranty

Warranty claims shall be voided in case

- Our conditions in the operation manual are ignored
- The appliance is used outside the described uses
- The appliance is modified or opened
- Mechanical damage or damage by media, liquids, natural wear and tear
- The appliance is improperly set up or incorrectly electrically connected
- The measuring system is overloaded

4.4 Monitoring of Test Resources

In the framework of quality assurance the measuring-related properties of the balance and, if applicable, the testing weight, must be checked regularly. The responsible user must define a suitable interval as well as type and scope of this test. Information is available on KERN's home page (www.kern-sohn.com) with regard to the monitoring of balance test substances and the test weights required for this. In KERN's accredited DKD calibration laboratory test weights and balances may be calibrated (return to the national standard) fast and at moderate cost.

5 Basic Safety Precautions

5.1 Pay attention to the instructions in the Operation Manual

Carefully read this operation manual before setup and commissioning, even if you are already familiar with KERN balances.

5.2 Personnel training

The appliance may only be operated and maintained by trained personnel.

6 Transport and storage

6.1 Testing upon acceptance

When receiving the appliance, please check packaging immediately, and the appliance itself when unpacking for possible visible damage.

6.2 Packaging

Keep all parts of the original packaging in case you need to return the appliance.

Only use original packaging for returning.

Before sending, disconnect all connected cables and loose/movable parts.

Attach possibly existing transport safeguards. Secure all parts, e.g. weighing plate, power unit etc., to prevent slipping and damage.

7 Unpacking, Setup and Commissioning

7.1 Installation Site, Location of Use

The balances are designed in a way that reliable weighing results are achieved in common conditions of use.

You will work accurately and fast, if you select the right location for your balance.

Therefore, observe the following for the installation site:

- Place the balance on a firm, level surface;
- Avoid extreme heat as well as temperature fluctuation caused by installing next to a radiator or in the direct sunlight;
- Protect the balance against direct draughts due to open windows and doors;
- Avoid jarring during weighing;
- Protect the balance against high humidity, vapours and dust;
- Do not expose the device to extreme dampness for longer periods of time. Non-permitted condensation (condensation of air humidity on the appliance) may occur if a cold appliance is taken to a considerably warmer environment. In this case, acclimatize the disconnected appliance for ca. 2 hours at room temperature.
- Avoid static charge of goods to be weighed or weighing container.

If electro-magnetic fields or static charge occur, or if the power supply is unstable major deviations on the display (incorrect weighing results) are possible. In that case, the location must be changed.

7.2 Unpacking

Carefully remove the balance from the packaging, remove plastic cover and setup balance at the intended workstation.

7.2.1 Setup

Level balance with foot screws until the air bubble of the water balance is in the pre-scribed circle.

7.2.2 Scope of delivery

Serial accessories:

- Balance
- Weighing plate
- Power cable
- Protective cover
- Battery
- Operating Manual

7.3 Mains connection

Power supply is carried out by means of the supplied power cable (220 V, 50-60 Hz).

7.4 Battery power supply

The battery is charged via the internal power supply.

Before the first use, the battery should be charged by connecting it to the mains power supply for at least 15 hours. The operating time of the battery is about. 70h. Charging time until complete recharging ca. 12h.

Selectable AUTO-OFF function after 1, 5, or 10 min (see chapt. 10) to protect the battery.

If an arrow shows in the weight display [▼] above the battery symbol  or “bat lo” the capacity of the battery will soon be exhausted. The balance will be ready to operate for about another 10 min., then it will switch off automatically. Connect the power adaptor as soon as possible to change the battery.

The LED display below the parts counting window informs you about the charge status of the battery.

red: Battery is almost discharged

green: Battery is completely discharged

yellow: Battery should be charged over a longer period (over night)

7.5 Initial Commissioning

A warming up time of 5 minutes after switching on stabilizes the measuring values. The accuracy of the balance depends on the local acceleration of gravity. Strictly observe hints in chapter Adjustment.







7.6 Adjustment

As the acceleration value due to gravity is not the same at every location on earth, each balance must be coordinated - in compliance with the underlying physical weighing principle - to the existing acceleration due to gravity at its place of location (only if the balance has not already been adjusted to the location in the factory). This adjustment process must be carried out for the first commissioning, after each change of location as well as in case of fluctuating environment temperature. To receive accurate measuring values it is also recommended to adjust the balance periodically in weighing operation.

Procedure when adjusting:

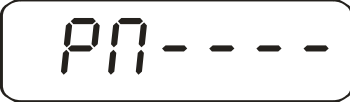
For verified balances adjustment by means of a jumper is locked. In order to carry out adjustment the two contacts of the conductor plate must be shorted with a jumper (see chapt. 7.7.1).

Observe stable environmental conditions. A warming up time of ca. 10 minutes is required for stabilization. Ensure that there are no objects on the weighing plate.

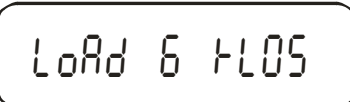
Operation	Display
Switch on balance	
Use the number keys to enter password „0000“:  confirmar	  
Ensure that there are no objects on the weighing plate. 	The required adjustment weight is displayed: 

Carefully place adjusting weight in the centre of the weighing plate



The adjustment process is started.

The adjustment process has been successfully completed.

Remove adjustment weight and jumper.

The balance returns to weighing mode

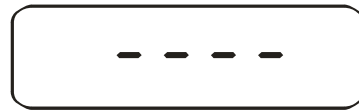

In case of an adjustment error or incorrect adjustment weight an error message is shown (*SPAN / FAIL*) on the display, repeat adjustment process.

7.7 Verification

General introduction:

According to EU directive 90/384/EEC balances must be officially verified if they are used as follows (legally controlled area):

- a) For commercial transactions if the price of goods is determined by weighing
- b) For the production of medicines in pharmacies as well as for analyses in the medical and pharmaceutical laboratory
- c) For official purposes.
- d) For manufacturing final packages.

In cases of doubt, please contact your local trade in standard.

After verification the balance is sealed at the indicated positions.

Verification of the balance is invalid without the "seal/lead seal".

Verification instructions

An EU type approval exists for balances described in their technical data as verifiable. If a balance is used where obligation to verify exists as described above, it must officially verified and re-verified in regular intervals.

Re-verification of a balance is carried out according to the respective national regulations. The validity for verification of balances in Germany is e.g. 2 years.

The legal regulation of the country where the balance is used must be observed!

Balances with obligation to verify must be taken out of operation if:

- **The weighing result of the balance is outside the error limit.** Therefore, in regular intervals load balance with known test weight (ca. 1/3 of the max. load) and compare with displayed value.
- **The reverification deadline has been exceeded.**

7.7.1 Jumper and seals

1. Bottom of the balance

Access to conductor plate:

- Place your balance upside down
- Remove seal
- For verified balances, the jumper is on a pin
- For adjustment the jumper must be set on both pins

Position jumper for adjustment

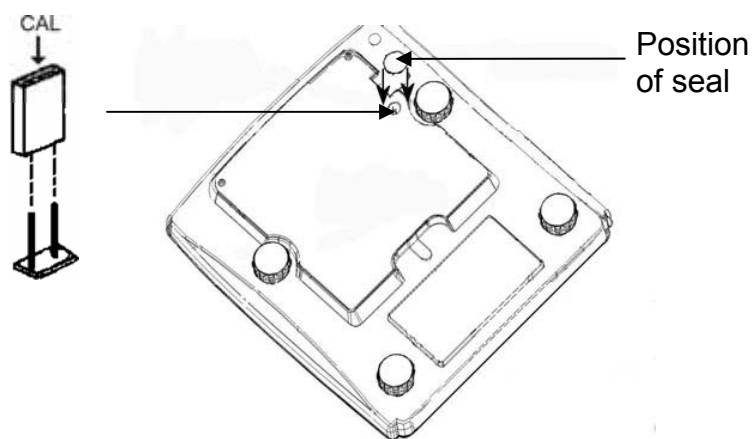

2. Top of the balance

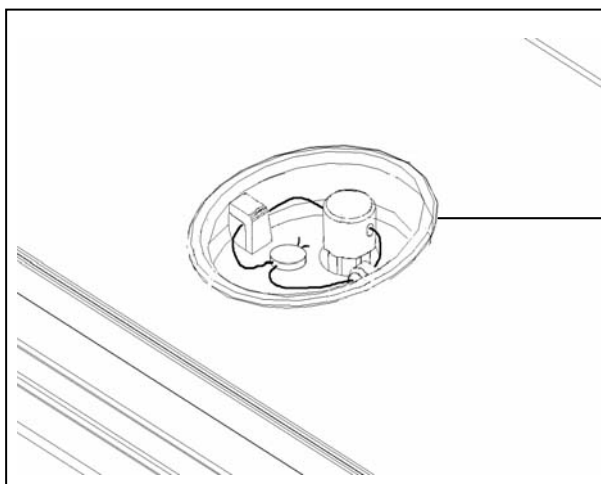

- Remove weighing plate



Sealing by seal or by lead seal

8 Operation

8.1 Switch on/off and set zero

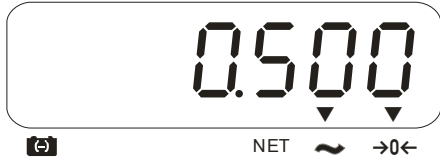

Operation	Display
<p>1. Switch on balance</p> <p>Press ON/OFF switch and hold briefly (at the bottom right side of the balance)</p> <p>The balance will carry out a self-test</p>	<p>As soon as the weight display shows "0" in all the three display windows your balance is ready to weigh.</p>
<p>2. Zeroing</p> 	 <p>The zero display and the arrow above the „→0←“ symbol are displayed.</p>

8.2 Simple weighing

Operation	Display
<p>Place goods onto weighing plate</p>	<p>Read weighing result</p>  <p>If weighing values are stable the arrow will be displayed above the ~ symbol.</p>
<p>If the goods are heavier than the weighing range, the display will show "oL" (=Overload), and a whistle is sounded.</p>	

8.3 Weighing with taring

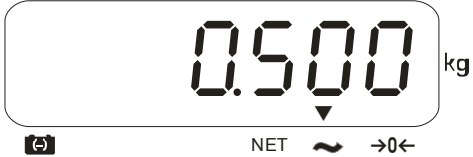
The dead weight of any weighing container may be tared away by pressing a button, so that the following weighings show the net weight of the goods to be weighed.

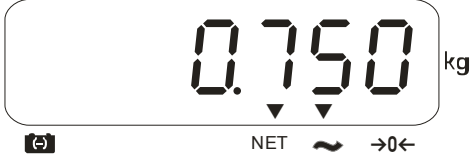
Operation	Display
Place empty tare container on the weighing plate. The total weight of the container is displayed.	
Reset display to "0": 	 <p>The weight of the container is now internally saved. Zero display and the arrow above the "NET" symbol are displayed.</p>
Place the goods to be weighed into the tare container.	Read the weight of the goods on the display. 

The taring process can be repeated any number of times, e.g. when adding several components for a mixture (adding).

8.4 Weighing with price determination

As soon as the goods to be weighed are placed on the balance and the basic price has been set the price is calculated automatically and displayed in the provided field.

8.4.1 Manual input of a basic price

Operation	Display		
	Weight [kg]	Basic price	Price [€]
If you are using a weighing container, tare	<i>0.000</i>	<i>0.00</i>	<i>0.00</i>
Place goods to be weighed on balance	<i>1.300</i>	<i>0.00</i>	<i>0.00</i>
Enter basic price via number keys; sales price is automatically calculated	<i>1.300</i>	<i>5.00</i>	<i>6.50</i>

8.4.2 Saving and calling up a basic price

- The balance is able to save up to 102 PLU values as basic price.
- The PLU value may be saved as €/kg or €/100 g.
- The keys M1 and M2 are used to save /call up the two most frequently used PLU values
- The other PLU values are saved/called up via the M3.-key.

Saving a basic price via the direct price keys M1, M2:

Operation	Display		
	Weight [kg]	Basic price	Price [€]
Enter a basic price via keyboard	<i>0.000</i>	<i>2.00</i>	<i>0.00</i>
 until there is a short beep (3 sec), then release the key	<i>PLU</i>	<i>1</i>	<i>5RUEd</i>
Entry for M2 is carried out in the same way			

Saving a unit price using the M3 key:

1. PLU 3



Operation	Display		
	Weight [kg]	Unit price	Price [€]
Enter your unit price using the keyboard, either in €/kg or €/100 g	0.000	2.00	0.00
 <p>until there is a short beep (3 sec), then release the key immediately</p>	SAUE	P05 00	
Wait until the display shows "PLU 3 saved". The unit price will be automatically saved under PLU 3.	PLU	3	SAUEd

2. Further PLU X values

Operation	Display		
	Weight [kg]	Unit price	Price [€]
Enter your unit price using the keyboard, either in €/kg or €/100 g	0.000	2.00	0.00
 <p>until there is a short beep (3 sec), then release the key immediately</p>	SAUE	P05 00	
Enter the numbers within 3 sec of your desired PLU or leave the value 00 for [PLU 3]		17	
The unit price is saved at the desired position. An acoustic signal acknowledges that the PLU has been saved.	PLU	17	SAUEd

To modify values which have been saved at a certain PLU position, simply repeat the procedure.

Call up a unit price:

Operation	Display		
	Weight [kg]	Unit price	Price [€]
  + PLU position	LORd	PoS 00	
	LORd	PoS 17	
The unit price saved at this position is displayed	0.000	2.00	0.00

Note: For the M1, M2 and M3 keys (no entry at position 00) only press the respective key to display the saved unit price.





8.5 AUTO CLEAR

Use the  key to activate the **AUTO-CLEAR** function; at the same time the arrow above "**AUTO CLEAR**" appears in the display.

Remove the goods to be weighed from the weighing plate, this way the set basic price will remain.





For activated **AUTO-CLEAR** function the set basic price is automatically deleted when the balance is unloaded.

9 Display background illumination

Operation	Display
 Hold for 4 sec	<p style="text-align: center;"><i>EL AU</i></p>
<p>To select your setting:</p>  Press until your desired setting is displayed	<ol style="list-style-type: none"> 1. Background illumination off <p style="text-align: center;"><i>EL OFF</i></p> 2. Background illumination on <p style="text-align: center;"><i>EL On</i></p> 3. Automatic background illumination on when weighing plate is loaded <p style="text-align: center;"><i>EL AU</i></p>
<p>Saving your settings:</p> 	<p>or return to weighing:</p> 

10 AUTO OFF function

For battery operation the balance has an automatic switch-off function which can be activated or deactivated in the menu. Proceed as follow

Operation	Display
Switch on balance and press the →0← key during self test 	<p style="text-align: center;">SLEEP MODE</p>
<p style="text-align: center;">To select your setting:</p>  Press until your desired setting is displayed	<ol style="list-style-type: none"> 1. Automatic switch off deactivated <p style="text-align: center;">SLEEP MODE 0</p> 2. Automatic switch off after 1 min <p style="text-align: center;">SLEEP MODE 1</p> 3. Automatic switch off after 5 min <p style="text-align: center;">SLEEP MODE 5</p> 4. Automatic switch off after 10 min <p style="text-align: center;">SLEEP MODE 10</p>
<p style="text-align: center;">Saving your settings:</p> 	<p style="text-align: center;">or return to weighing:</p> 

11 Data Interface RS 232C

As standard, the balance is fitted with an RS 232C interface.

11.1 Technical data

- ASCII code
- 8 data bits
- no parity bit
- baud rate 4800 baud

11.2 Pin allocation for the balance output socket (front view)

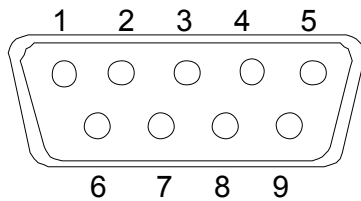

- Pin 2: Receive data
- Pin 3: Transmit data
- Pin 5: Signal ground

11.3 Parameter selection

- To access the menu, hold the PRINT key pressed for 4 seconds
- Use the PRINT key for parameter selection
- Confirm your settings using the TARE key, the next menu option will be displayed

Display			Selection options	Function
Weight	Unit price	Total price		
Port	on		on or oFF	RS 232C on/off
4800	bPS		600, 1200, 2400, 4800, 9600 or 19200	Baud rate
LABEL	1		1 or 2	Output format selection
CoUntr	Y E	nGLiSH	EnGLiSH, FrEnCH, GErMAN or SPAniSH	Language selection
StErLi	ng		EUroPE, dOLLAr, StErLinG	Currency selection

Example of output format (German/Euro):

Label 1

08/01/2007		07:56:38	

GRUNDPREIS	NETTO	SUMME	
€ 1.20/100g	0.200 kg	€ 2.40	

Label 2

DATUM	08/01/2007		
ZEIT	07:56:38		
GRUNDPREIS	€	1.20/100g	
NETTO	0.200 kg		
SUMME	€	2.40	

11.4 Setting the date/time

- During power up of the balance, press the C key and hold it pressed until the revision number of the balance is displayed. Then release the C key, the set date/time is displayed:
"rtC" „08,01,07“ „16,41,35"
- Press the C key, the current time format "H-m-S" is displayed.
- Enter the time (24 hour format) using the number keys (e.g. 3:41 PM = "154100)
- Confirm the entry with the TARE key, the set date is displayed
- Select the desired format with the PRINT key:
"Y-m-d" = Year-Month-Day
"m-d-Y" = Month-Day-Year
"d-m-Y" = Day-Month-Year
- Confirm the selected format with the TARE key
- Enter the date using the number keys
- Confirm the entry with the TARE key. If an entry is not permitted (e.g. 34.12.07) then the error messages **Err1** (time) or **Err 2** (date) will be displayed. The balance returns to weighing mode automatically.

11.5 Remote control instructions

T<cr><lf>	Taring
Z<cr><lf>	Zeroing
P<cr><lf>	Data output

12 Service, maintenance, disposal

12.1 Cleaning

Before cleaning, please disconnect the appliance from the operating voltage.

Please do not use aggressive cleaning agents (solvents or similar agents), but a cloth dampened with mild soap suds. Ensure that no liquid penetrates into the device and wipe with a dry soft cloth.

Loose residue sample/powder can be removed carefully with a brush or manual vacuum cleaner.

Spilled weighing goods must be removed immediately.

12.2 Service, maintenance

The appliance may only be opened by trained service technicians who are authorized by KERN.

Before opening, disconnect from power supply.

12.3 Disposal

Disposal of packaging and appliance must be carried out by operator according to valid national or regional law of the location where the appliance is used.

13 Instant help

In case of an error in the program process, briefly turn off the balance and disconnect from power supply. The weighing process must then be restarted from the beginning.

Fault	Possible cause
<i>The displayed weight does not glow.</i>	<ul style="list-style-type: none"> • <i>The balance is not switched on.</i>
	<ul style="list-style-type: none"> • <i>The mains supply connection has been interrupted (mains cable not plugged in/faulty).</i>
	<ul style="list-style-type: none"> • <i>Power supply interrupted.</i>
	<ul style="list-style-type: none"> • <i>Batteries are inserted incorrectly or empty</i>
	<ul style="list-style-type: none"> • <i>No batteries inserted.</i>
<i>The displayed weight is permanently changing</i>	<ul style="list-style-type: none"> • <i>Draught/air movement</i>
	<ul style="list-style-type: none"> • <i>Table/floor vibrations</i>
	<ul style="list-style-type: none"> • <i>Weighing plate has contact with other objects.</i>
	<ul style="list-style-type: none"> • <i>Electromagnetic fields / static charging (choose different location/switch off interfering device if possible)</i>
<i>The weighing result is obviously incorrect</i>	<ul style="list-style-type: none"> • <i>The display of the balance is not at zero</i>
	<ul style="list-style-type: none"> • <i>Adjustment is no longer correct.</i>
	<ul style="list-style-type: none"> • <i>Great fluctuations in temperature.</i>
	<ul style="list-style-type: none"> • <i>Electromagnetic fields / static charging (choose different location/switch off interfering device if possible)</i>

Should other error messages occur, switch balance off and then on again. If the error message remains inform manufacturer.